

# CURRENT PRODUCTS model:AF208

## SLS INTERFACE

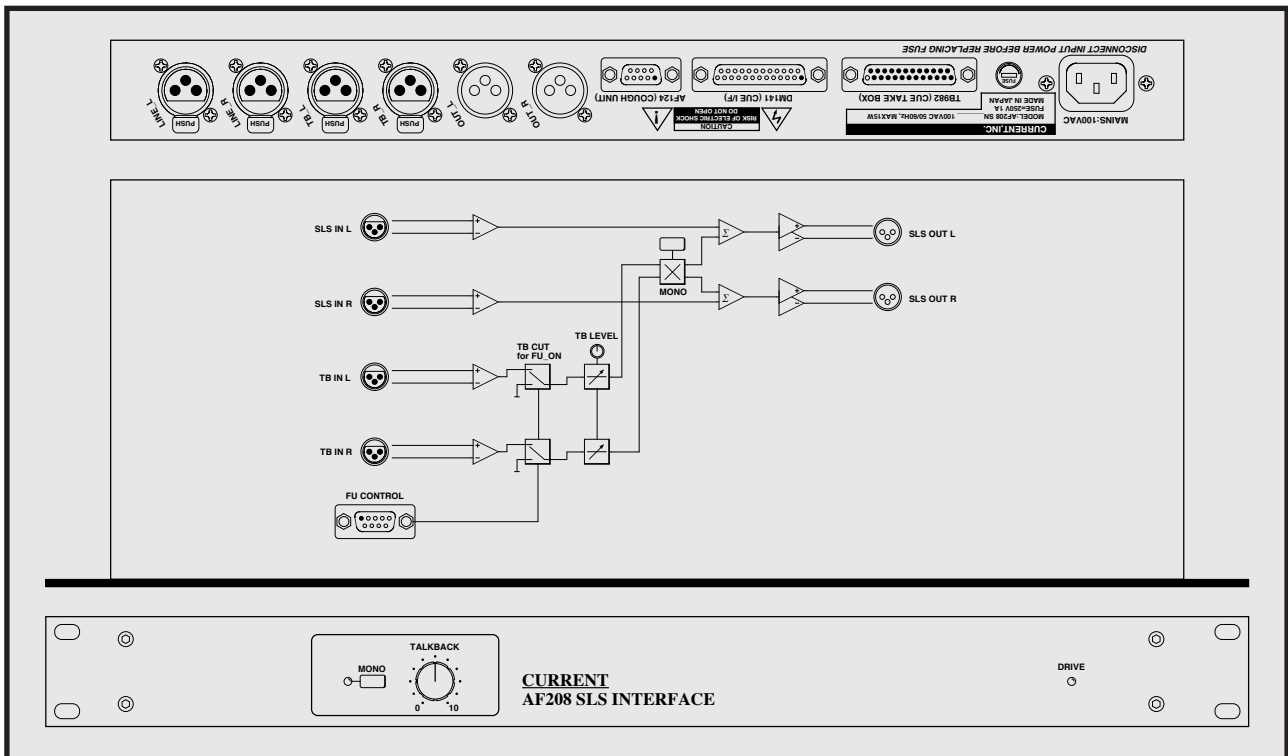

Studio TB control  
Stereo mono talkback  
CM countdown function  
19 inches 1U size

*When it broadcasts it with keeping studio speaker in booth alive, AF208 is interface to cut TB signal automatically by cough ON.*

### "TB control"

TB signal input into AF208 is mixed with program in state of cough OFF, and it is output to studio speaker, but TB signal is cut when it becomes ON cough. It supports stereo, and TB signal can set level with front panel. Moreover, it can make it monaural with MONO button.

### "CM countdown"

It connects optional TB982, and countdown display of 20 seconds is possible by external CM tarry.

### "Others"

Please refer about special specifications other than AF208.

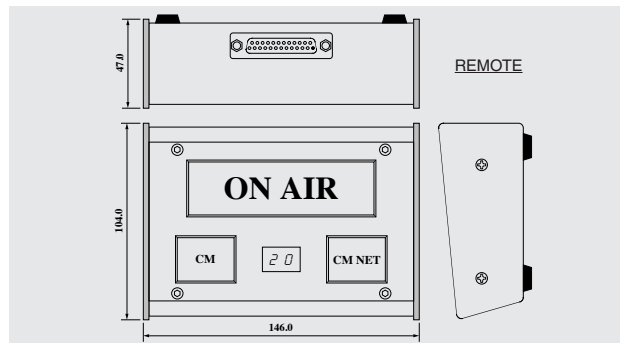

### SPECIFICATIONS

- 🍏 **SLS INPUTS:** BALANCED STEREO  
12k $\Omega$ , REF=+4dBu, MAX=+24dBu, XLR3-F
- 🍏 **SLS OUTPUTS:** BALANCED 50 $\Omega$  STEREO  
REF=+4dBu, MAX=+24dBu, XLR3-M
- 🍏 **TB INPUTS:** BALANCED STEREO  
12k $\Omega$ , REF=+4dBu, MAX=+24dBu, XLR3-F
- 🍏 **CONTROL:** TB LEVEL, MONO TB
- 🍏 **COUGH CONTROL INPUT:** Dsub9-M (#4-40)
- 🍏 **TALLY CONTROL INPUT:** Dsub25-M (#4-40)
- 🍏 **CUE TAKE BOX TB982:** Dsub25-F (#4-40)
- 🍏 **FREQUENCY RESPONSE:** 20Hz~20kHz  $\pm$ 0.1dB
- 🍏 **THD:** < 0.01% at 1kHz REFERENCE LEVEL
- 🍏 **MAINS:** 100VAC 50/60Hz, 15W MAX
- 🍏 **DIMENSIONS:** 482Wx44Hx303D, 4kg



SLS Interface	AF208	¥298,000
AF208 remote unit	TB982	¥98,000
Remote cable 10m	AF208W10	¥32,000
accessory : AC cable		

2-26-11 AKATSUTSUMI, SETAGAYA-KU, TOKYO, 156-0044 JAPAN TEL:81-3-3321-9559 FAX:81-3-5376-2735

The specifications are subject to change without notice.

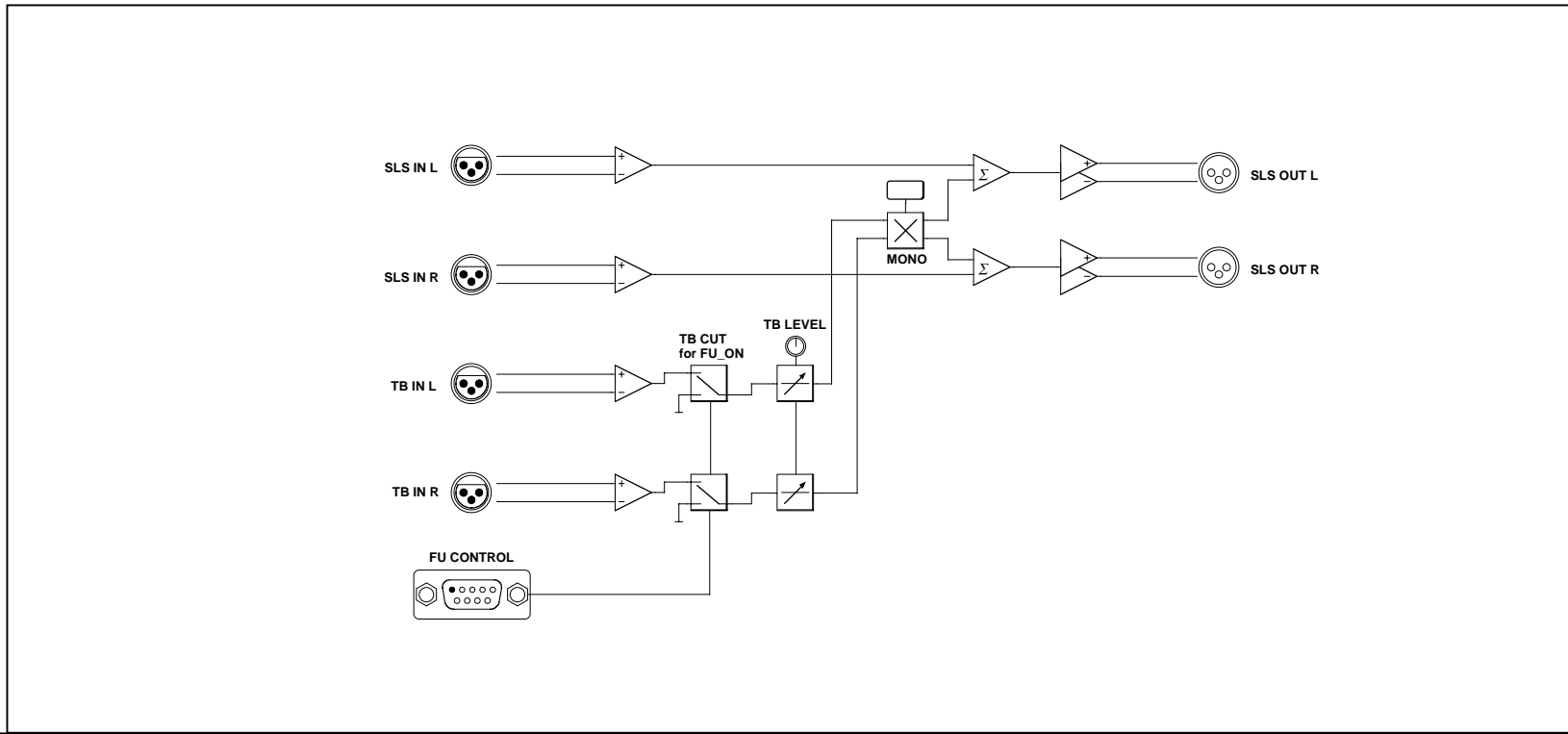
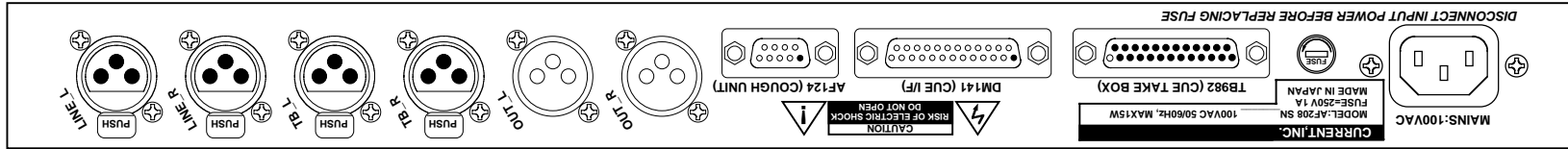

302.6

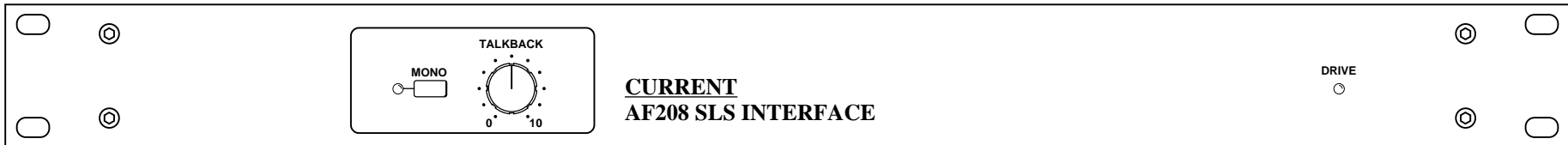

44.0

482.0

(c)CURRENT,INC.	<b>AF208 SLS INTERFACE</b>	MAY 98
H.ICHIHASHI	<b>PANEL DIAGRAM</b>	AF208-D

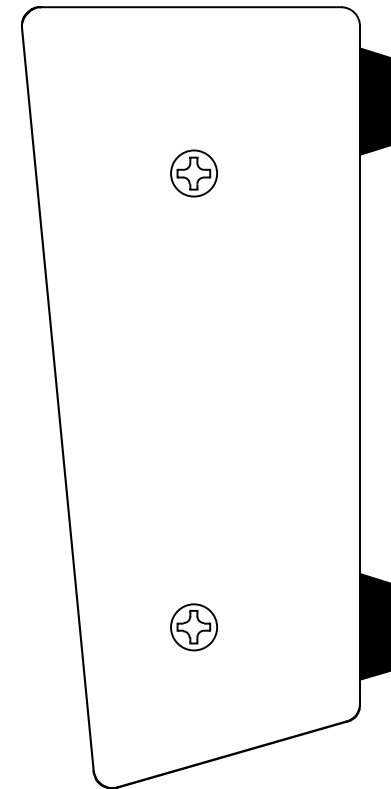
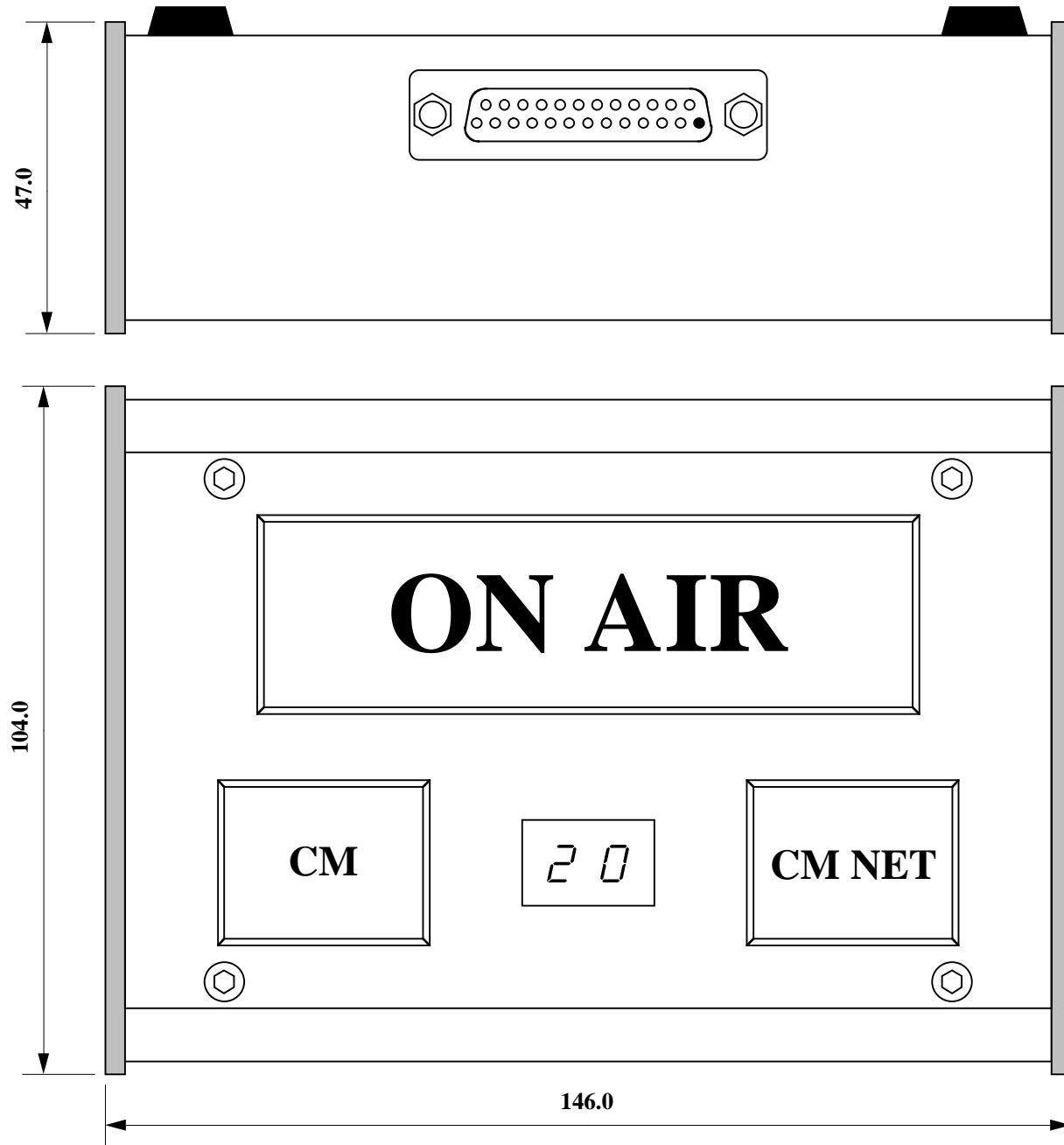

CONNECTOR:D15-M(#4-40)

(c)CURRENT,INC.	CUE TAKE BOX TB982	May.98
H.ICHIIHASHI	PANEL DIAGRAM	TB982-D

## AF208 "AF124" Connector Pin List D9-M(#4-40)

Ribbon	Hard	Signal name	Designation	Active
1	1	0V	GND	
2	6	+12V	+12V DC SUPPLY	
3	2	Y-FU+	FU COMMAND INPUT +	+15V
4	7	Y-FU-	FU COMMAND INPUT -	0V
5	3			
6	8			
7	4			
8	9			
9	5			

Y-FU+ 及び、Y-FU- はフォトカプラーの定電流入力です。相手側機器の電源をY-FU+ オープンコレクタ出力をY-FU-へ接続してください。 + 5 V D C ~ + 2 4 V D C まで動作可能です。相手機器にリレーなどの接点しかない場合には、 + 1 2 V を利用してください。

注意！ Dサブコネクタの接続はHARDピン番号で接続してください。取付は#4-40インチビスです。

**CAUTION! D-Connector for wiring refer toHard pin number Description. Mounting screw for D-connector use #4-40 size.**

## AF208 "TB982" Connector Pin List (D25-F #4-40)

Ribbon	Hard	Signal name	Designation	Active
1	1	LOCAL SW a	LOCAL SWITCH CONTACT a	
2	14	LOCAL SW b	LOCAL SWITCH CONTACT b	
3	2	NET SW a	NET SWITCH CONTACT a	
4	15	NET SW b	NET SWITCH CONTACT b	
5	3	LOCAL LP+	LOCAL LAMP +	+5V
6	16	LOCAL LP-	LOCAL LAMP -	Lo
7	4	NET LP+	NET LAMP +	+5V
8	17	NET LP-	NET LAMP -	Lo
9	5	OA LP +	ON AIR LAMP +	+12V
10	18	OA LP-	ON AIR LAMP -	-12V
11	6	7SEG A	-20' DISPLAY a	
12	19	7SEG B	-20' DISPLAY b	
13	7	7SEG C	-20' DISPLAY c	
14	20	7SEG D	-20' DISPLAY d	
15	8	7SEG E	-20' DISPLAY e	
16	21	7SEG F	-20' DISPLAY f	
17	9	7SEG G	-20' DISPLAY g	
18	22	7SEG 10S	-20' DISPLAY COMMON 10S	-
19	10	7SEG 1S	-20' DISPLAY COMMON 1S	-
20	23			
21	11			
22	24			
23	12			
24	25			
25	13			

注意！ Dサブコネクタの接続はHARDピン番号で接続してください。取付は#4-40インチビスです。

**CAUTION! D-Connector for wiring refer toHard pin number Description. Mounting screw for D-connector use #4-40 size.**

## AF208 "DM141" Connector Pin List (D25-M #4-40)

Ribbon	Hard	Signal name	Designation	Active
1	1	CUE IN A	LOCAL SWITCH CONTACT a	
2	14	CUE TLY A1	LOCAL OA TALLY INPUT	Lo
3	2	CUE IN COM A	LOCAL SWITCH CONTACT b	
4	15	CUE TLY A2	GND	
5	3	CUE IN B	NET SWITCH CONTACT a	
6	16	CUE TLY B1	NET OA TALLY INPUT	Lo
7	4	CUE IN COM B	NET SWITCH CONTACT b	
8	17	CUE TLY B2	GND	
9	5	CUE IN C	NC	
10	18	CUE TLY C1	NC	
11	6	CUE IN COM C	NC	
12	19	CUE TLY C2	NC	
13	7	CUE IN D	NC	
14	20	CUE TLY D1	-20' TALLY INPUT	Lo
15	8	CUE IN COM D	NC	
16	21	CUE TLY D2	GND	
17	9			
18	22			
19	10			
20	23			
21	11			
22	24			
23	12			
24	25			
25	13			

注意！ Dサブコネクタの接続はHARDピン番号で接続してください。取付は#4-40インチビスです。

**CAUTION! D-Connector for wiring refer toHard pin number Description. Mounting screw for D-connector use #4-40 size.**