

CURRENT PRODUCTS model:CSP312

AES SWITCHER

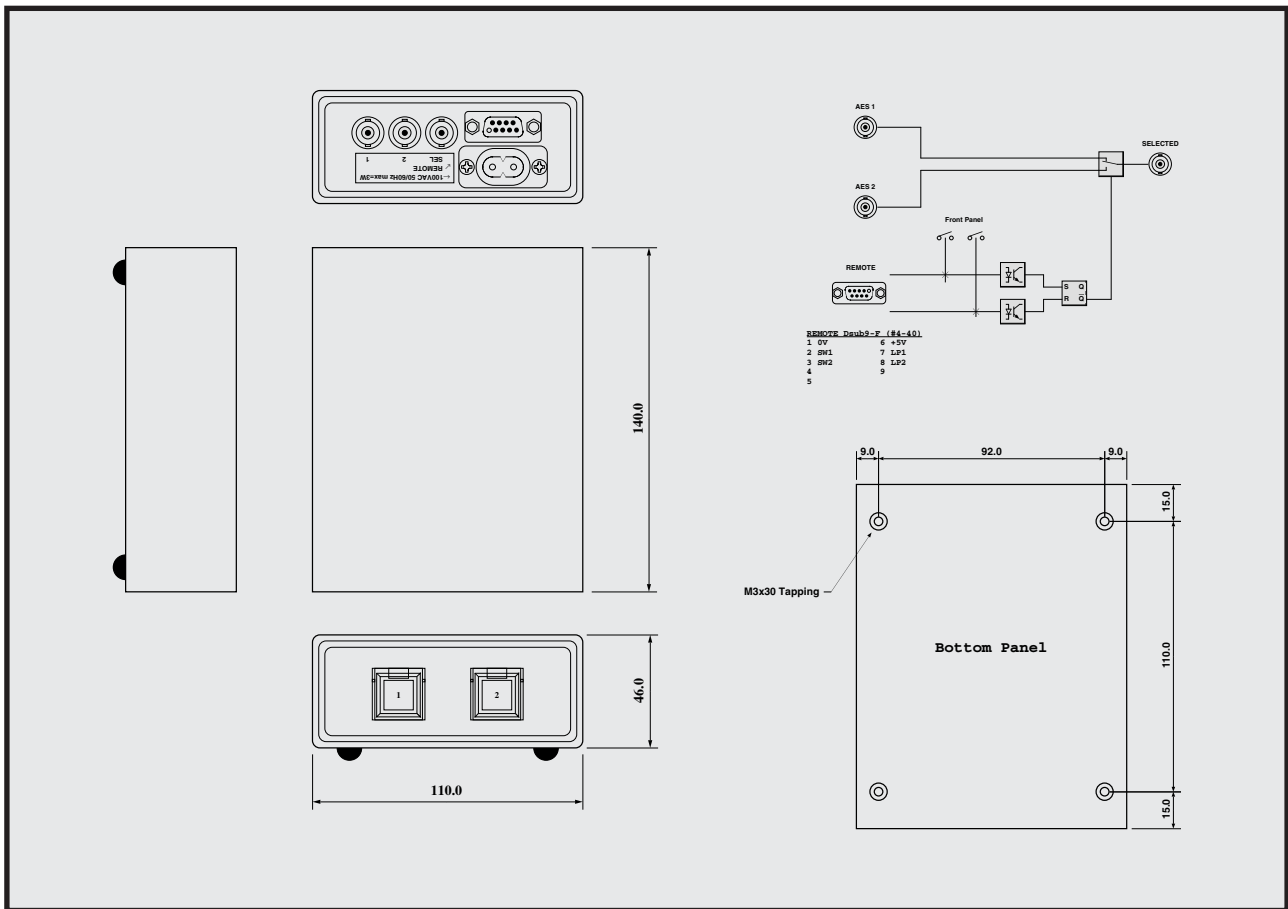

2:1 AES switcher
 BNC connector
 Locality, remote control
 Bypasses it with power off
 Compact

CSP312 is an AES switcher of 2:1 specifications of the BNC connector.

The remote control is possible with front panel or a DSUB connector of the rear panel, too.

"Function"

It chooses either of 2 input at momentary contact connected to a DSUB connector of rear panel connected to front panel in parallel and outputs it.

When a command is input simultaneously, input 1 is chosen.

In addition, input 1 is chosen at the time of the power-up.

"Bypass"

In the case of the power off, input 1 completely bypasses it, and it is output.

"Connector"

The input and output is a BNC connector both.

The input that is not chosen is terminated at 75 ohm.

"Others"

Please consider also the GPS722 of a 19-inch rack mount support analog and digital.

REMOTE DSUB9-F

01 0V (sw com)	06 +5V
02 SW1	07 LP1
03 SW2	08 LP2
04	09
05	

SPECIFICATIONS

- 🍏 **INPUTS:** 2ch, impedance=75Ω
- 🍏 **INPUT CONNECTORS:** BNC
- 🍏 **OUTPUTS:** 1ch, impedance=75Ω
- 🍏 **OUTPUT CONNECTORS:** BNC
- 🍏 **REMOTE:** Dsub9-F #4-40
- 🍏 **MAINS:** 100VAC 50/60Hz, MAX 3W
- 🍏 **DIMENSIONS:** 150Wx54Hx170D 1kg

Order number: CSP312 ¥120,000
 accessory : AC cable

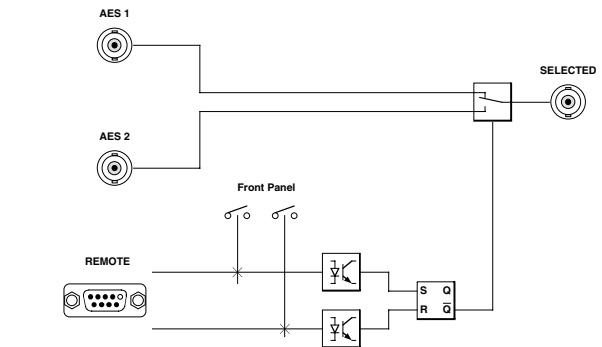
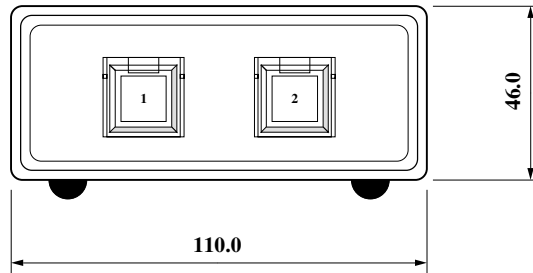
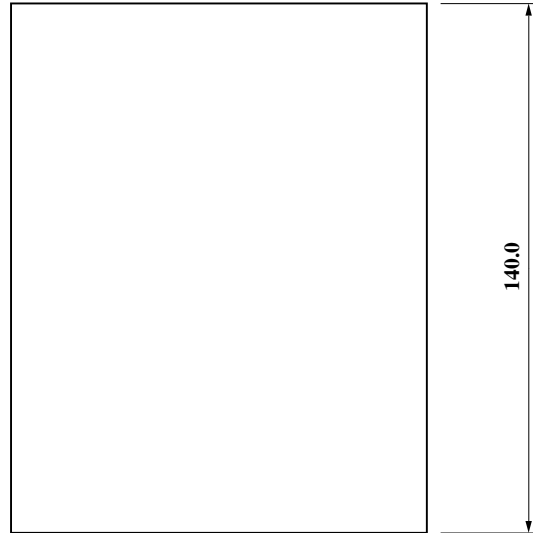
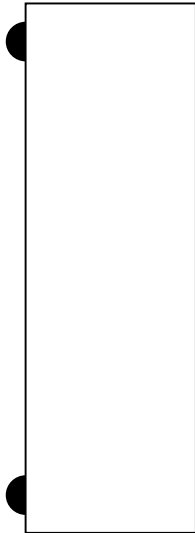
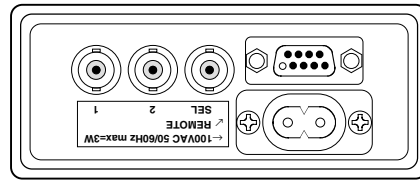

- REMOTE Dsub9-F (#4-40)**
- | | |
|-------|-------|
| 1 0V | 6 +5V |
| 2 SW1 | 7 LP1 |
| 3 SW2 | 8 LP2 |
| 4 | 9 |
| 5 | |

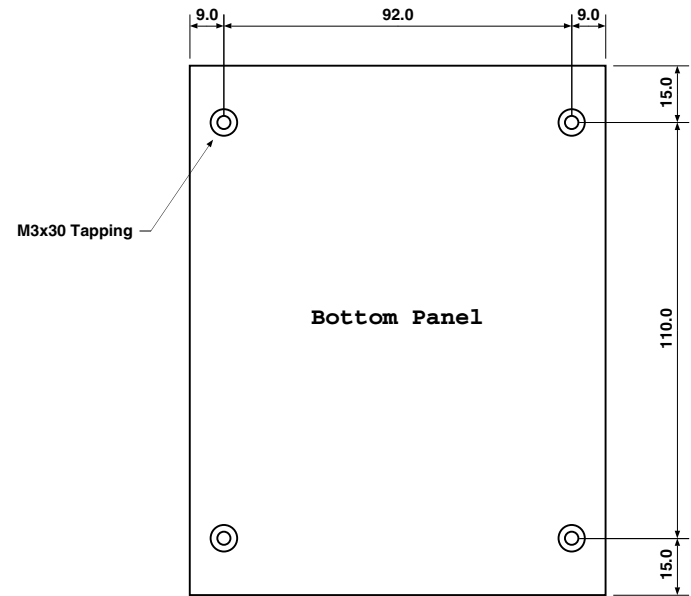

(c)CURRENT,INC.	CSP312 AES SWITCHER	Feb.2011
H.ICHIHASHI	PANEL DIAGRAM	CSP312-D