

CURRENT PRODUCTS model:SL901A

AUDIO SWITCHER

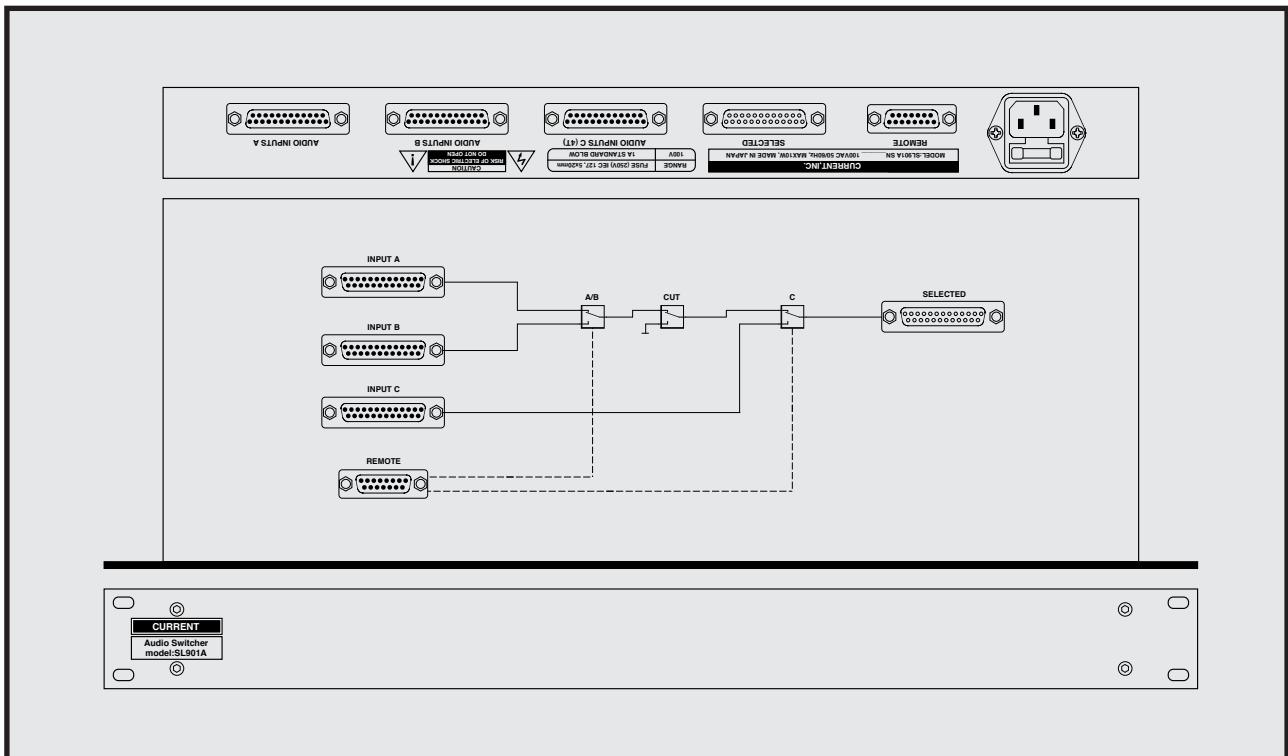

8 channels, 3 path audio switchers

Remote control

4T, 8T switch

Relay system

19 inches 1U size

SL901A is 3 path input audio switchers of 8ch. A and the B source after the selection can cut 1 8ch individually and are most suitable for a switch of the surround source of the 8-track. Additionally, it is available for an emergency switcher purpose because A is chosen at the time of the power-off.

"Relay system"

It uses a relay for an audio switch of SL901A and can ignore the deterioration of sound quality such as the aggravation of the distortion, the increase of the noise. Additionally, it is available for the switch except the audio.

"Switch mode"

A switch of A and B input 8 channels into is possible and can do all mute afterwards. When it chooses C input, 1-4 switches to C input, and 5-8 is mute. It can apply it to 4T, 8T switch using this function. Additionally, A and the B input can cut 8 channels individually.

"Remote"

SL901A is a remote control type, and a remote panel, the box are not included. An internal logic does not have a latch circuit, and, therefore, it is necessary to use the tarry that made the switch of the alternate type or hold. It manufactures the remote panels to specifications extra.

"Others"

Please refer about the specifications of the non-standard.

SPECIFICATIONS

- 🍏 **AUDIO INPUT A:** BALANCED, Dsub25-F (#4-40)
- 🍏 **AUDIO INPUT B:** BALANCED, Dsub25-F (#4-40)
- 🍏 **AUDIO INPUT C:** BALANCED, Dsub25-F (#4-40)
- 🍏 **AUDIO OUTPUT:** BALANCED, Dsub25-M (#4-40)
- 🍏 **REMOTE:** Dsub15-F (#4-40)
- 🍏 **MAINS:** 100VAC 50/60Hz, MAX=10W
- 🍏 **DIMENSIONS:** 482Wx44Hx303D, 4kg

Audio switcher	SL901A	¥320,000
----------------	--------	----------

accessory : AC cable

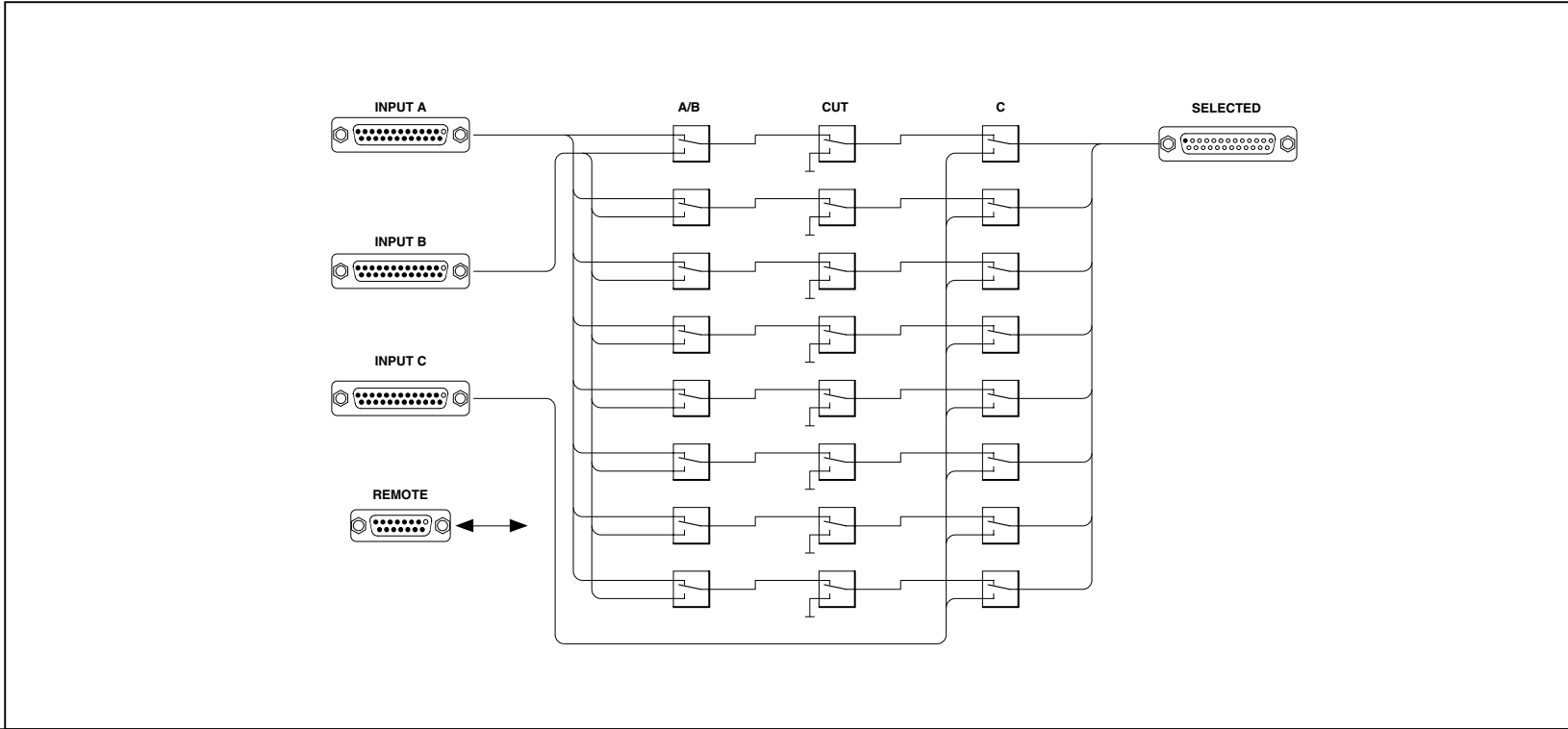
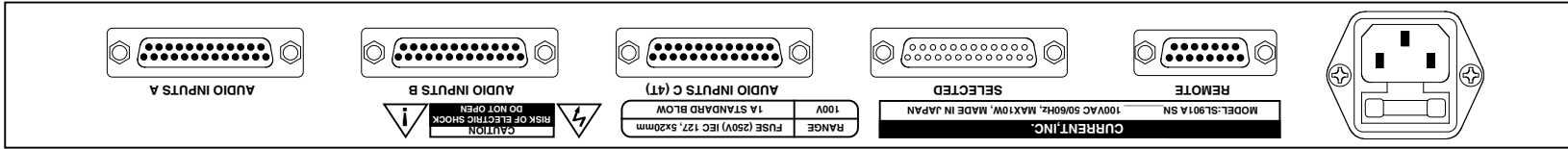

302.6



44.0

482.0

CURRENT,INC.	AUDIO SWITCHER SL901A	OCT.97
H.CHIHASHI	PANEL DIAGRAM	SL901A-D

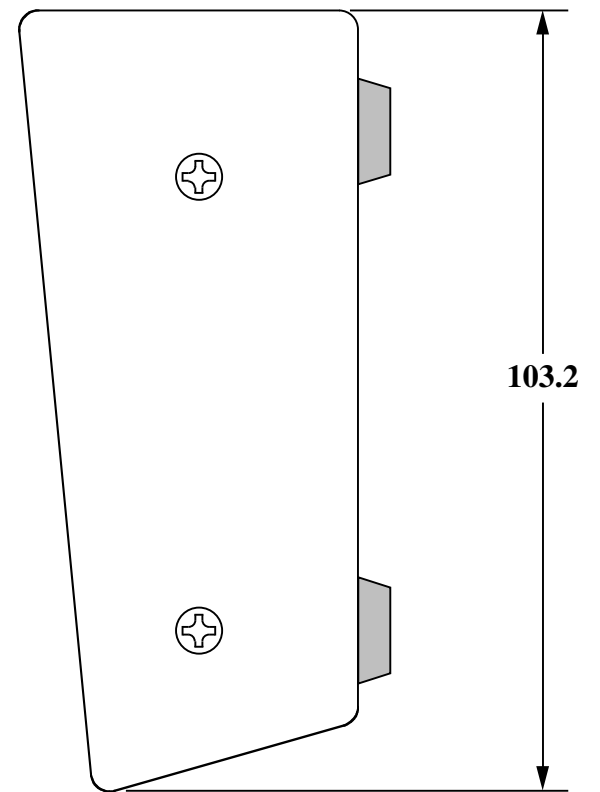
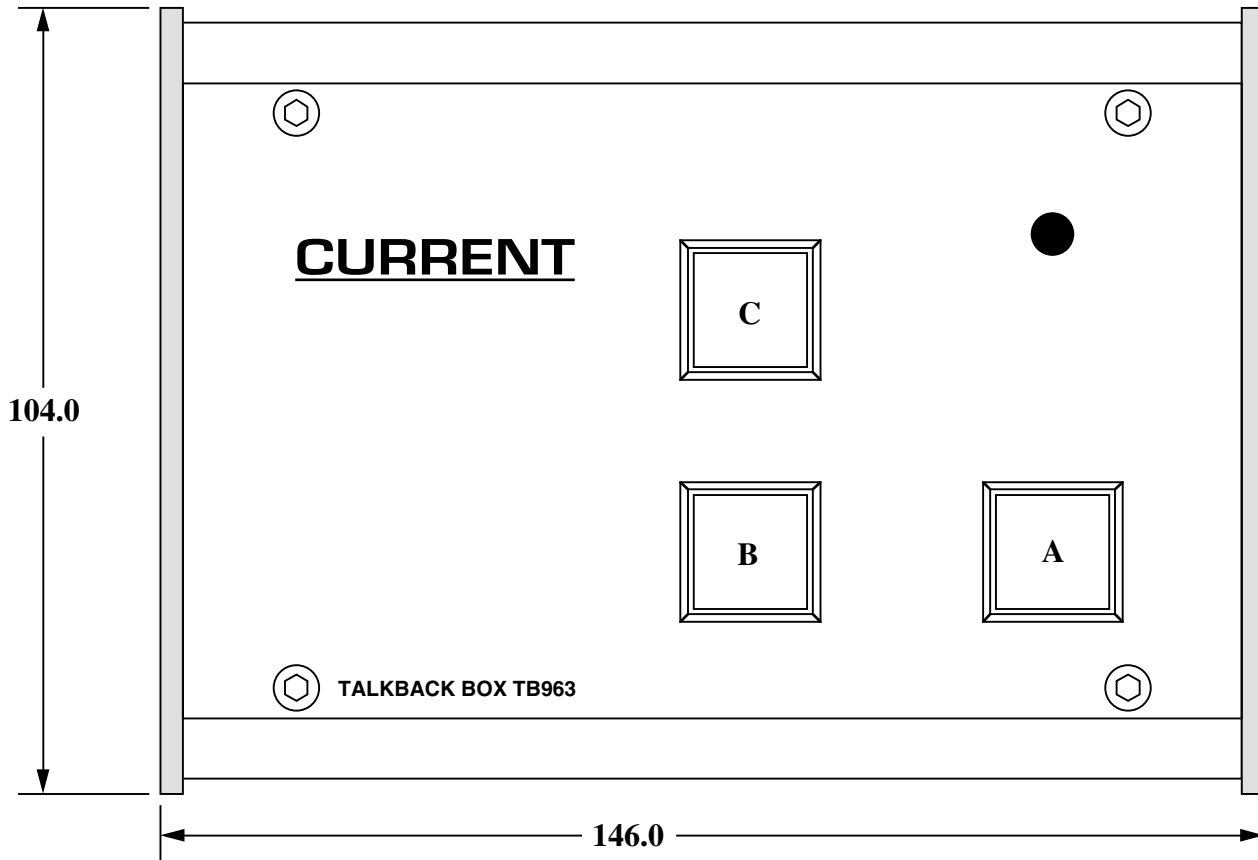
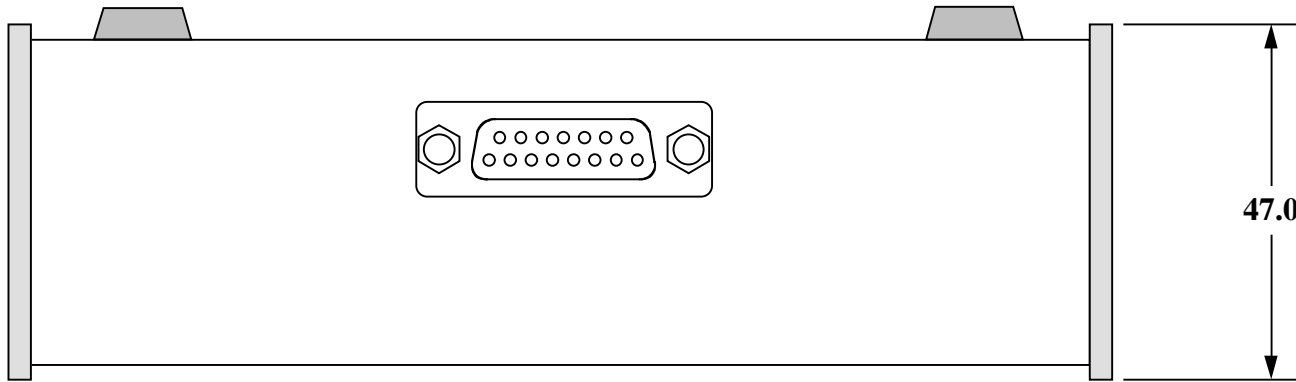

CONNECTOR:D15-M(#4-40)

CURRENT,INC.	SL901A Remote Box	Dec.2001
H.ICHIHASHI	PANEL DIAGRAM	SL901A-rem

D25-F (#4-40)

D25-M (#4-40)

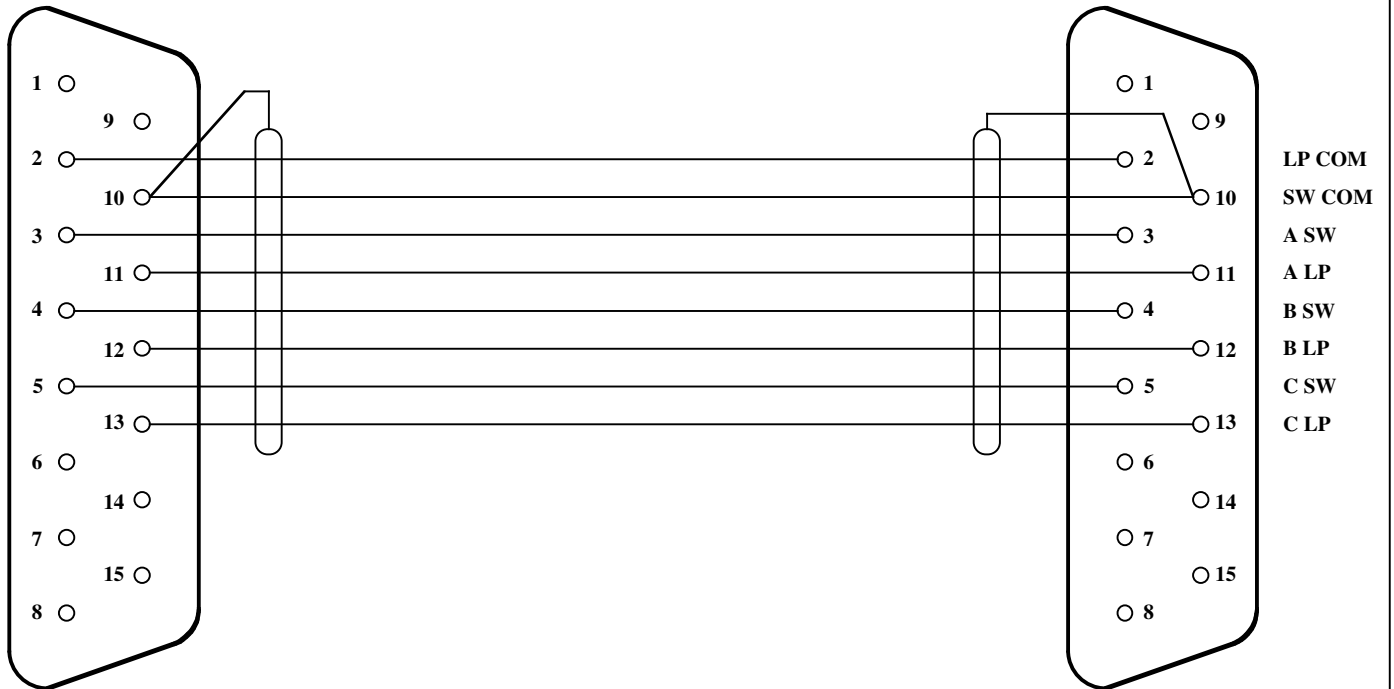

(c)CURRENT,INC.	SL901A	Dec.2001
H.ICHIHASHI	Remote Box Cable Diagram	SL901A remote cable

SL901A "NPUTS-A" D25-F(#4-40) Connector Pin List

Ribbon	Hard	Signal name	Designation	Active
1	1	AUDIO INPUT A1+	AUDIO INPUT A1 HOT	
2	14	AUDIO INPUT A1-	AUDIO INPUT A1 COLD	
3	2	AUDIO INPUT A1G	AUDIO INPUT A1 GND	
4	15	AUDIO INPUT A2+	AUDIO INPUT A2 HOT	
5	3	AUDIO INPUT A2-	AUDIO INPUT A2 COLD	
6	16	AUDIO INPUT A2G	AUDIO INPUT A2 GND	
7	4	AUDIO INPUT A3+	AUDIO INPUT A3 HOT	
8	17	AUDIO INPUT A3-	AUDIO INPUT A3 COLD	
9	5	AUDIO INPUT A3G	AUDIO INPUT A3 GND	
10	18	AUDIO INPUT A4+	AUDIO INPUT A4 HOT	
11	6	AUDIO INPUT A4-	AUDIO INPUT A4 COLD	
12	19	AUDIO INPUT A4G	AUDIO INPUT A4 GND	
13	7	AUDIO INPUT A5+	AUDIO INPUT A5 HOT	
14	20	AUDIO INPUT A5-	AUDIO INPUT A5 COLD	
15	8	AUDIO INPUT A5G	AUDIO INPUT A5 GND	
16	21	AUDIO INPUT A6+	AUDIO INPUT A6 HOT	
17	9	AUDIO INPUT A6-	AUDIO INPUT A6 COLD	
18	22	AUDIO INPUT A6G	AUDIO INPUT A6 GND	
19	10	AUDIO INPUT A7+	AUDIO INPUT A7 HOT	
20	23	AUDIO INPUT A7-	AUDIO INPUT A7 COLD	
21	11	AUDIO INPUT A7G	AUDIO INPUT A7 GND	
22	24	AUDIO INPUT A8+	AUDIO INPUT A8 HOT	
23	12	AUDIO INPUT A8-	AUDIO INPUT A8 COLD	
24	25	AUDIO INPUT A8G	AUDIO INPUT A8 GND	
25	13	N.C.	No Connection	

注意！ Dサブコネクタの接続はHARDピン番号で接続してください。

取付ビスは#4-40インチビスを使用して下さい

CAUTION! D-Connector for wiring refer toHard pin number Description.

Mounting screw for D-connector use #4-40 size.

SL901A "INPUTS-B" D25-F(#4-40) Connector Pin List

Ribbon	Hard	Signal name	Designation	Active
1	1	AUDIO INPUT B1+	AUDIO INPUT B1 HOT	
2	14	AUDIO INPUT B1-	AUDIO INPUT B1 COLD	
3	2	AUDIO INPUT B1G	AUDIO INPUT B1 GND	
4	15	AUDIO INPUT B2+	AUDIO INPUT B2 HOT	
5	3	AUDIO INPUT B2-	AUDIO INPUT B2 COLD	
6	16	AUDIO INPUT B2G	AUDIO INPUT B2 GND	
7	4	AUDIO INPUT B3+	AUDIO INPUT B3 HOT	
8	17	AUDIO INPUT B3-	AUDIO INPUT B3 COLD	
9	5	AUDIO INPUT B3G	AUDIO INPUT B3 GND	
10	18	AUDIO INPUT B4+	AUDIO INPUT B4 HOT	
11	6	AUDIO INPUT B4-	AUDIO INPUT B4 COLD	
12	19	AUDIO INPUT B4G	AUDIO INPUT B4 GND	
13	7	AUDIO INPUT B5+	AUDIO INPUT B5 HOT	
14	20	AUDIO INPUT B5-	AUDIO INPUT B5 COLD	
15	8	AUDIO INPUT B5G	AUDIO INPUT B5 GND	
16	21	AUDIO INPUT B6+	AUDIO INPUT B6 HOT	
17	9	AUDIO INPUT B6-	AUDIO INPUT B6 COLD	
18	22	AUDIO INPUT B6G	AUDIO INPUT B6 GND	
19	10	AUDIO INPUT B7+	AUDIO INPUT B7 HOT	
20	23	AUDIO INPUT B7-	AUDIO INPUT B7 COLD	
21	11	AUDIO INPUT B7G	AUDIO INPUT B7 GND	
22	24	AUDIO INPUT B8+	AUDIO INPUT B8 HOT	
23	12	AUDIO INPUT B8-	AUDIO INPUT B8 COLD	
24	25	AUDIO INPUT B8G	AUDIO INPUT B8 GND	
25	13	N.C.	No Connection	

注意！ Dサブコネクタの接続はHARDピン番号で接続してください。

取付ビスは#4-40インチビスを使用して下さい

CAUTION! D-Connector for wiring refer toHard pin number Description.

Mounting screw for D-connector use #4-40 size.

SL901A "INPUTS-C" D25-F(#4-40) Connector Pin List

Ribbon	Hard	Signal name	Designation	Active
1	1	AUDIO INPUT C1+	AUDIO INPUT C1 HOT	
2	14	AUDIO INPUT C1-	AUDIO INPUT C1 COLD	
3	2	AUDIO INPUT C1G	AUDIO INPUT C1 GND	
4	15	AUDIO INPUT C2+	AUDIO INPUT C2 HOT	
5	3	AUDIO INPUT C2-	AUDIO INPUT C2 COLD	
6	16	AUDIO INPUT C2G	AUDIO INPUT C2 GND	
7	4	AUDIO INPUT C3+	AUDIO INPUT C3 HOT	
8	17	AUDIO INPUT C3-	AUDIO INPUT C3 COLD	
9	5	AUDIO INPUT C3G	AUDIO INPUT C3 GND	
10	18	AUDIO INPUT C4+	AUDIO INPUT C4 HOT	
11	6	AUDIO INPUT C4-	AUDIO INPUT C4 COLD	
12	19	AUDIO INPUT C4G	AUDIO INPUT C4 GND	
13	7	N.C.	N.C.	
14	20	N.C.	N.C.	
15	8	N.C.	N.C.	
16	21	N.C.	N.C.	
17	9	N.C.	N.C.	
18	22	N.C.	N.C.	
19	10	N.C.	N.C.	
20	23	N.C.	N.C.	
21	11	N.C.	N.C.	
22	24	N.C.	N.C.	
23	12	N.C.	N.C.	
24	25	N.C.	N.C.	
25	13	N.C.	N.C.	

注意！ Dサブコネクタの接続はHARDピン番号で接続してください。

取付ビスは#4 - 40インチビスを使用して下さい

CAUTION! D-Connector for wiring refer toHard pin number Description.

Mounting screw for D-connector use #4-40 size.

SL901A "SELECTED" D25-M(#4-40) Connector Pin List

Ribbon	Hard	Signal name	Designation	Active
1	1	AUDIO SELECTED 1+	AUDIO SELECTED 1 HOT	
2	14	AUDIO SELECTED 1-	AUDIO SELECTED 1 COLD	
3	2	AUDIO SELECTED 1G	AUDIO SELECTED 1 GND	
4	15	AUDIO SELECTED 2+	AUDIO SELECTED 2 HOT	
5	3	AUDIO SELECTED 2-	AUDIO SELECTED 2 COLD	
6	16	AUDIO SELECTED 2G	AUDIO SELECTED 2 GND	
7	4	AUDIO SELECTED 3+	AUDIO SELECTED 3 HOT	
8	17	AUDIO SELECTED 3-	AUDIO SELECTED 3 COLD	
9	5	AUDIO SELECTED 3G	AUDIO SELECTED 3 GND	
10	18	AUDIO SELECTED 4+	AUDIO SELECTED 4 HOT	
11	6	AUDIO SELECTED 4-	AUDIO SELECTED 4 COLD	
12	19	AUDIO SELECTED 4G	AUDIO SELECTED 4 GND	
13	7	AUDIO SELECTED 5+	AUDIO SELECTED 5 HOT	
14	20	AUDIO SELECTED 5-	AUDIO SELECTED 5 COLD	
15	8	AUDIO SELECTED 5G	AUDIO SELECTED 5 GND	
16	21	AUDIO SELECTED 6+	AUDIO SELECTED 6 HOT	
17	9	AUDIO SELECTED 6-	AUDIO SELECTED 6 COLD	
18	22	AUDIO SELECTED 6G	AUDIO SELECTED 6 GND	
19	10	AUDIO SELECTED 7+	AUDIO SELECTED 7 HOT	
20	23	AUDIO SELECTED 7-	AUDIO SELECTED 7 COLD	
21	11	AUDIO SELECTED 7G	AUDIO SELECTED 7 GND	
22	24	AUDIO SELECTED 8+	AUDIO SELECTED 8 HOT	
23	12	AUDIO SELECTED 8-	AUDIO SELECTED 8 COLD	
24	25	AUDIO SELECTED 8G	AUDIO SELECTED 8 GND	
25	13	N.C.	No Connection	

注意！ Dサブコネクタの接続はHARDピン番号で接続してください。

取付ビスは#4-40インチビスを使用して下さい

CAUTION! D-Connector for wiring refer toHard pin number Description.

Mounting screw for D-connector use #4-40 size.

SL901A "REMOTE" D15-F(#4-40) Connector Pin List

Ribbon	Hard	Signal name	Designation	Active
1	1	SW COM	SWITCH COMMON	0V
2	9	CUT1	CHANNEL CUT SWITCH 1	L
3	2	CUT2	CHANNEL CUT SWITCH 2	L
4	10	CUT3	CHANNEL CUT SWITCH 3	L
5	3	CUT4	CHANNEL CUT SWITCH 4	L
6	11	CUT5	CHANNEL CUT SWITCH 5	L
7	4	CUT6	CHANNEL CUT SWITCH 6	L
8	12	CUT7	CHANNEL CUT SWITCH 7	L
9	5	CUT8	CHANNEL CUT SWITCH 8	L
10	13	A/B	SELECT PORT B SWITCH	L
11	6	8T/4T	SELECT 4T SWITCH (SELECT PORT C)	L
12	14			
13	7			
14	15			
15	8			

注意！ D サブコネクタの接続はHARDピン番号で接続してください。

取付ビスは# 4-40インチビスを使用して下さい

CAUTION! D-Connector for wiring refer toHard pin number Description.

Mounting screw for D-connector use #4-40 size.